

Serenity Rail Shower

Nero

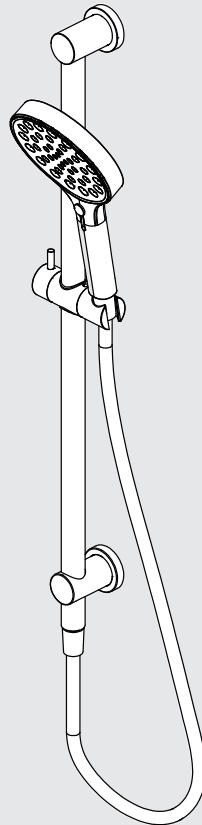

Versions:202506



Drawing

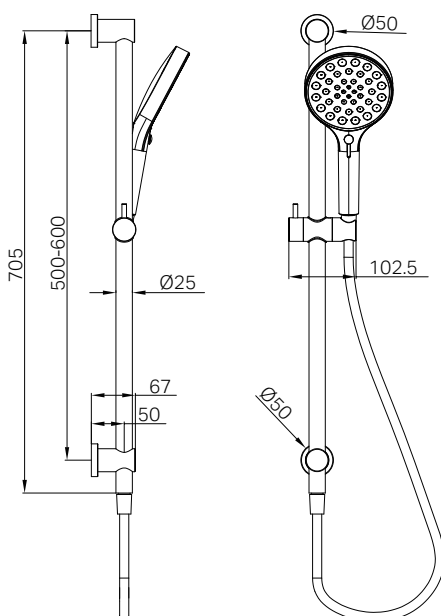

Specifications

Watermark License

WM-060093







Temperature Rating

Min 1°C - Max 75°C

Pressure Rating

Min 150kpa - Max 500kpa

Finish & SKU

 Chrome 24D072CH	 Gun Metal 24D072GM	 Brushed Bronze 24D072BZ
 Matte Black 24D072MB	 Brushed Gold 24D072BG	 Brushed Nickel 24D072BN

Packaging Includes

- 1x Shower Rail
- 1x Hand Shower (Built- In Check Valve)
- 1x 1.5m PVC Hose
- 2x Backplates
- 1x Installation Kit

*Dimensions are nominal measurements only.
**Dual-check valve pre-installed.

Installation Instruction

GENERAL INSTRUCTIONS:

- This product must be installed by a licensed plumber. Ensure that your plumbing installation conforms to the Australian/New Zealand Standard AS/NZS 3500.
- All pipework must be thoroughly flushed prior to the installation of the shower. In-line filters must be fitted on both hot and cold supplies to prevent foreign particles from damaging the shower components.
- Ensure that all outlets used for personal hygiene deliver water at a safe temperature in accordance with regional regulations.
- Verify that the water pressure is within the recommended range for the shower to function properly.

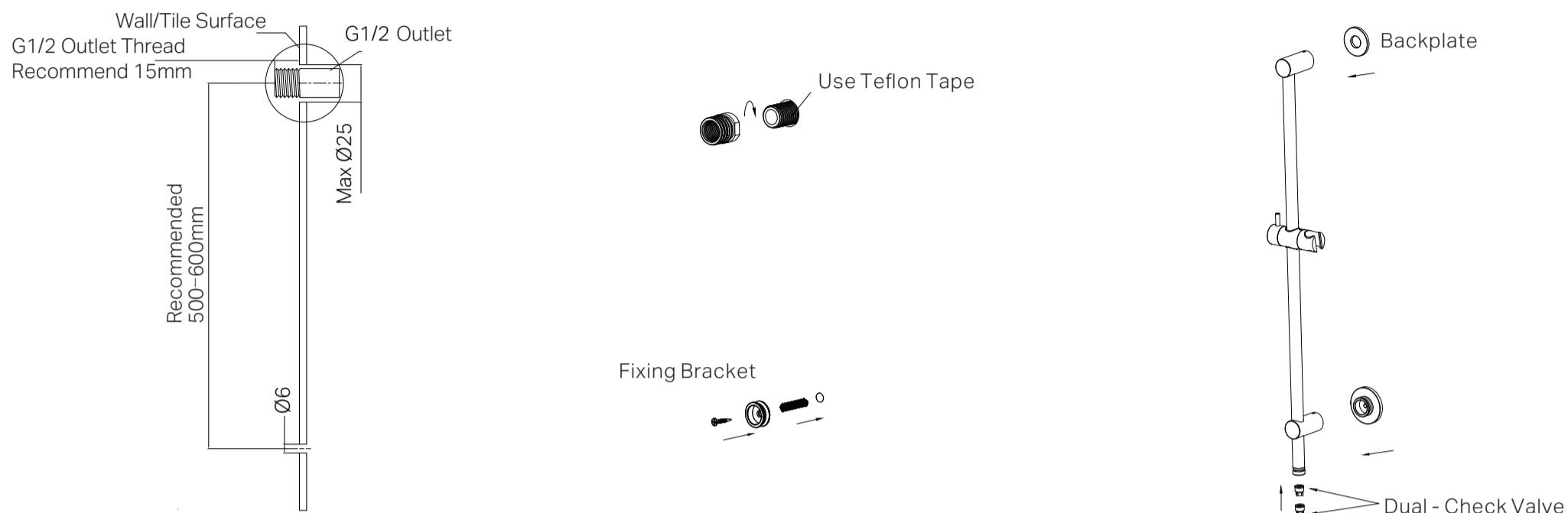

1. Ensure the G1/2 outlet thread extends 15mm beyond the finished wall or tile surface; trim the thread if necessary to achieve this length.

Mark the appropriate position for the mounting hole, ensuring it is within the recommended range of 500mm to 600mm below the inlet point.

Drill a 6mm hole at the marked point, ensuring it is perpendicular to the wall for a secure installation.

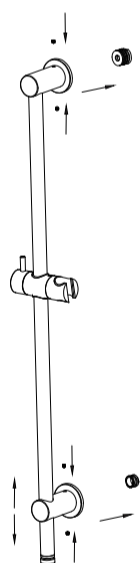

4. Position the shower rail assembly over the wall adaptors and press it firmly into place. Secure the assembly by tightening the grub screws with the provided Allen key.

2. Apply the G1/2 water outlet connection with Teflon tape to ensure a watertight seal. Screw the adapter onto the prepared outlet thread. Insert expansion plug into the 6mm hole. Attach the outlet adapter. Position the brass fixing bracket against the wall and secure it firmly using self-tapping screws. Ensure the fixing bracket is level and stable for optimal support.

3. Slide the backplates onto the top and the bottom mounting pillar.

Note: Dual-check valve are pre-installed in the shower rail.

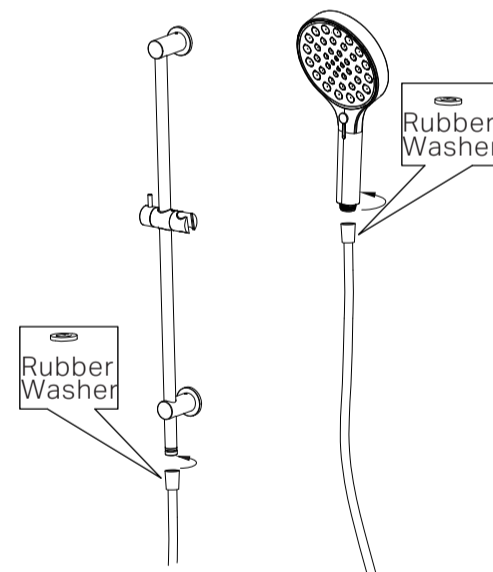

5. Attach the hand shower to the hose and connect the hose to the shower rail, ensuring that rubber washers are in place at both connection points to prevent leaks.

Confirm that all connections are securely tightened, then activate the drainage system and turn on the water supply.

Inspect all connections for any signs of leakage.

MAINTENANCE AND CARE:

- Regularly check the shower system and all connections for signs of wear or leaks.
- Clean all shower components with mild soapy water to maintain their appearance, avoiding harsh chemicals and abrasive materials that may damage the finish.
- Descale the showerhead, hand shower, and other components periodically to prevent mineral buildup, which can affect water flow and performance.
- Inspect and replace any worn-out parts, such as seals or washers, to ensure the longevity and efficiency of the shower system.
- Ensure all moving parts, such as adjustable brackets or sliding rails, are functioning smoothly and are properly lubricated if necessary.

FINAL INSPECTION:

- Ensure the shower operates smoothly and that there are no leaks at the connections.
- Verify that the water temperature and flow are consistent and as desired.
- Clean the area and the newly installed shower with a soft cloth to remove any installation residues.

Nero

